

Core Alignment Fusion Splicer Quick Reference Guide

What's included

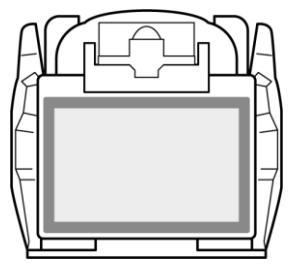

Fusion splicer

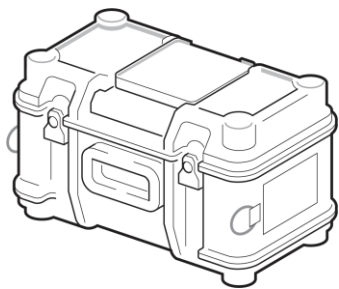

Carrying case

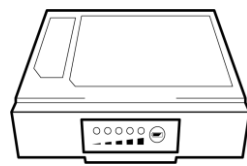

Battery pack

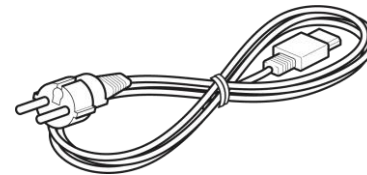

Power cord



Quick reference guide

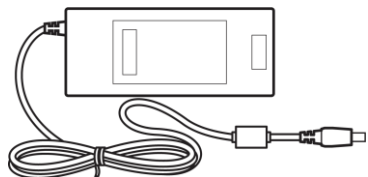

AC adapter



Electrodes

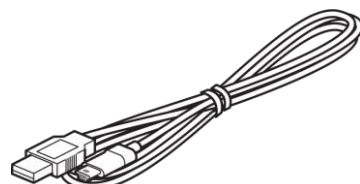

USB cable

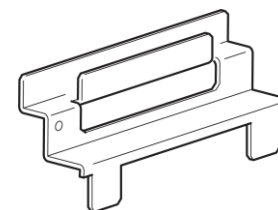

Cooling tray

Getting started

- 1 Open the battery slot cover located at the bottom of the splicer and insert the battery pack. Close and lock the cover.

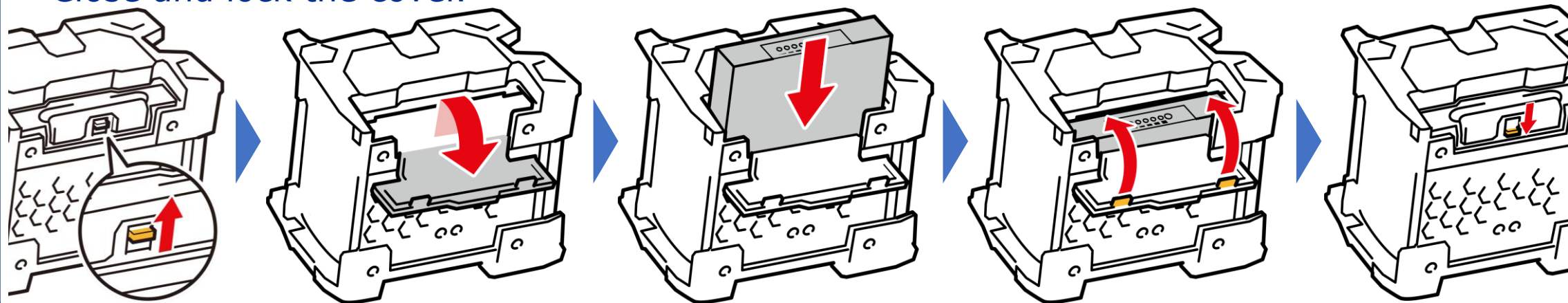

- 2 Connect the AC adapter to the splicer to charge the battery pack.

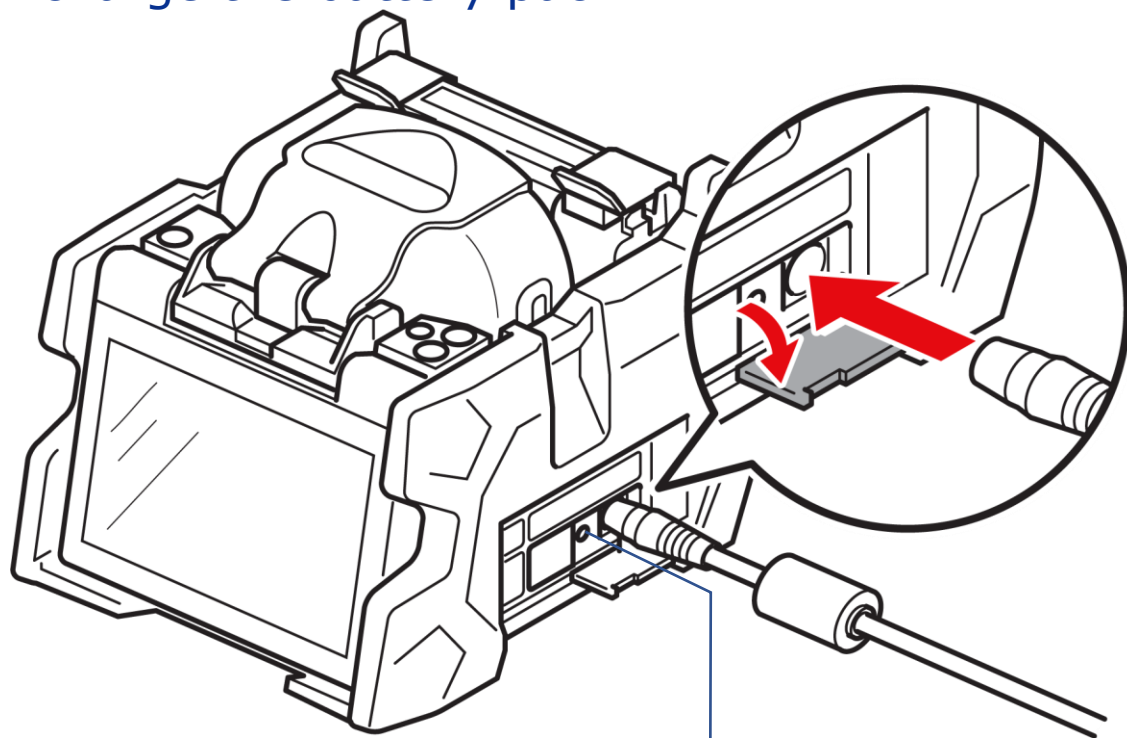

- How to check battery capacity left

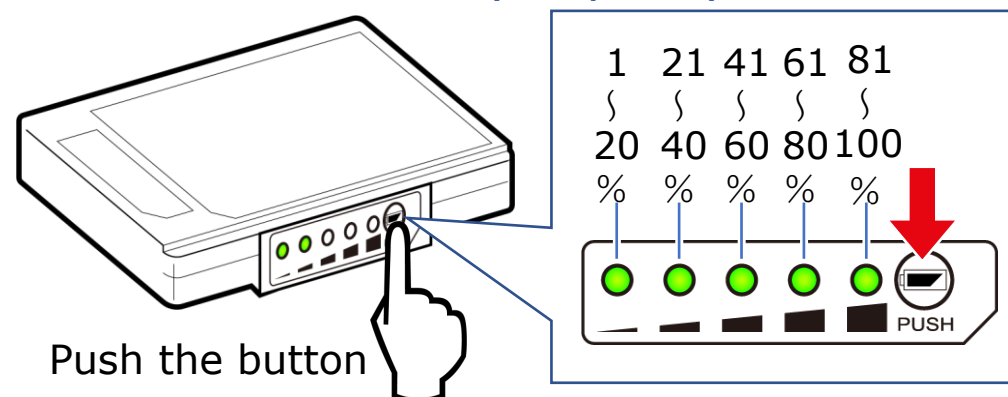

- 3 Press the POWER key.
- 4 The splicer turns on.

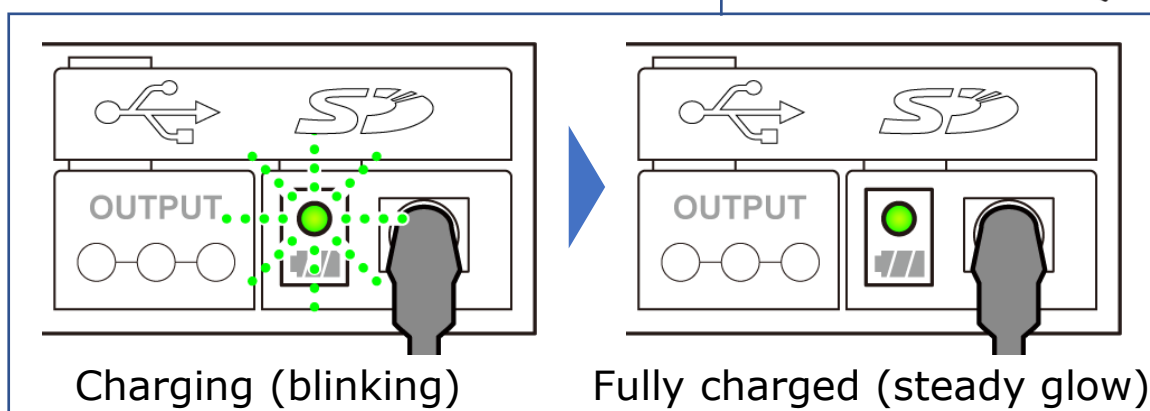
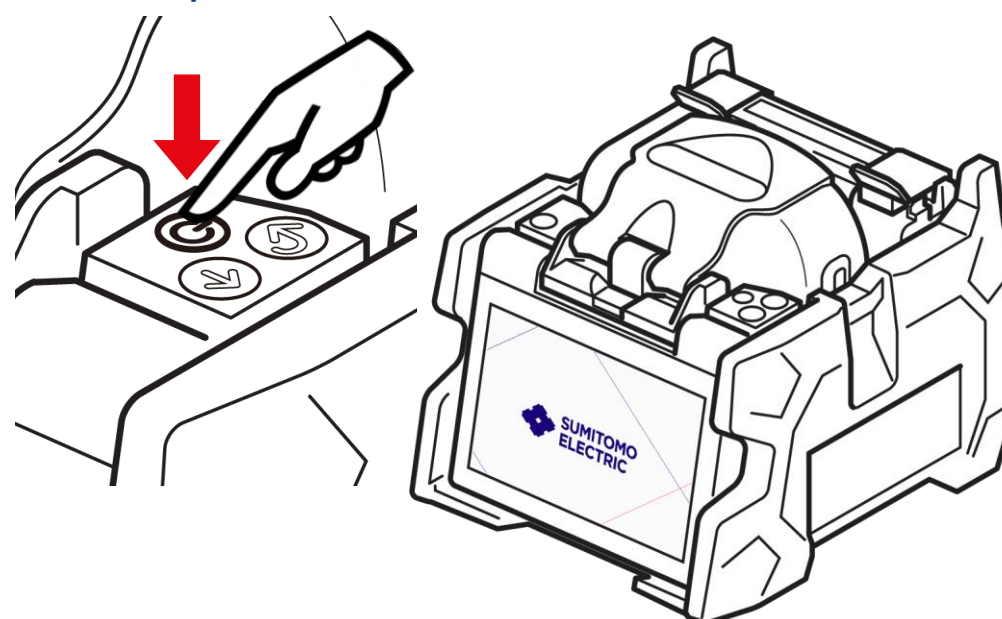

5 The splicer shows thumbnails of tutorial videos.



6 Tap the thumbnail to play the video.

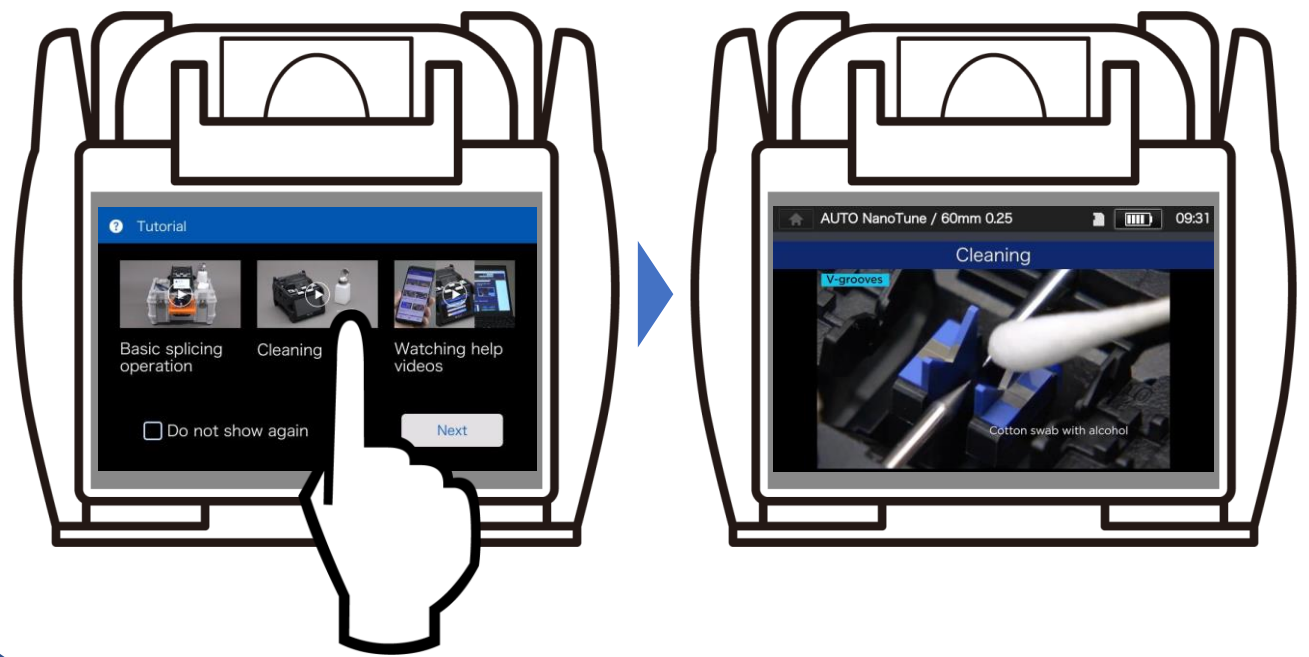

Utilizing Help Videos

On the splicer



Also available online



Video contents

Basic operation



Inserting the fibers into the splicer



Splice protection



V-grooves



Heat shrink oven

Consumables



Replacing the electrodes

Software update



On a computer

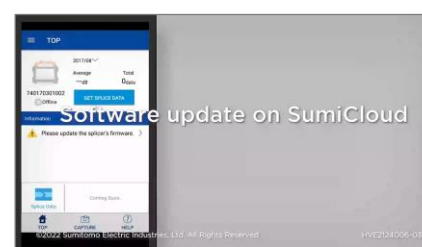

On SumiCloud

... and more in the list.

